

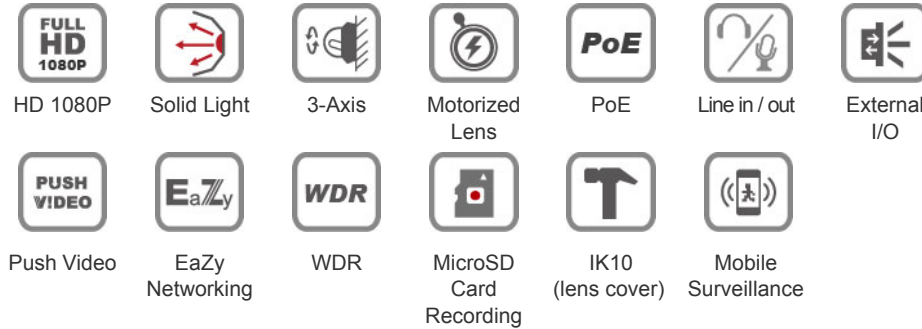

# AVM543



## 2MP IR Dome IP Camera

### FEATURES

- Equipped with a **motorized vari-focal lens of f2.8 ~ 12 mm**, focal length and focus adjustment could be made remotely
- **3-axis** mechanism for flexible ceiling and wall-mount installation
- **Free P2P Cloud EaZy Networking**
  - Cloud **EaZy Networking** available to connect this device to Internet automatically in three steps with our free mobile app, EagleEyes.
  - The **Buddy** feature to share the device access permission to other people.
  - Device login / out notifications reported.

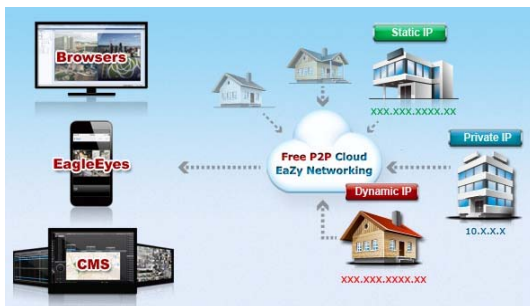

- MicroSD card support (up to 64GB) for **video storage**
- **External alarm I/O device** connection
- **POE (Power-over-Ethernet)** support to eliminate the use of power cables and reduce installation costs

- **ONVIF (ONVIFS)** standard supported to simplify system integration
- **Solid Light** series featuring better overexposure prevention (Advanced Smart Light Control), automatic adjustment of image brightness, and longer lifetime of LEDs
- **WDR** to increase image recognizability in overexposure and dark areas
- **IK10** rated, vandal-resistant case to withstand attempts to open or damage the camera
- **Line in / out** jacks available for audio transmission
- **Waterproof** design on the Ethernet cable connector
- **Remote Surveillance**
  - **Fully compatible** with **iOS** and **Android** devices, and **Internet Explorer** on Windows operating system
  - Free PC program, **CMS Lite**, for 32CH devices monitoring on Windows operating system
  - **Push Video** available on your iOS and Android devices



## SPECIFICATIONS

### Network

LAN Port	YES
LAN Speed	10/100 Based-T Ethernet
Supported Protocols	DDNS, PPPoE, DHCP, NTP, SNTP, TCP/IP, ICMP, SMTP, FTP, HTTP, RTP, RTSP, RTCP, IPv4/IPv6, Bonjour, UPnP, DNS, UDP, IGMP, QoS, SNMP
ONVIF Compatible	YES (Profile S)
Number of Online Users	10
Security	(1) Multiple user access levels with password (2) IP address filtering (3) Digest authentication
Remote Access	(1) Internet Explorer on Windows operating system (2) CMS Lite, 32CH CMS software for Windows operating system (3) EagleEyes on iOS & Android mobile devices

### Video

Network Compression	H.264 (Main Profile) / MJPEG
Video Resolution	1920 x 1080 / 1280 x 720 / 720 x 480 / 352 x 240
Frame Rate	30/25fps
Multiple Video Streaming	4 (H.264 / MJPEG)

### General

Image Sensor	1/ 2.8" SONY CMOS image sensor
Min Illumination	0.1 Lux / F1.4 ~ F2.8, 0 Lux (IR LED ON)
Shutter Speed	1/10,000 ~ 1/7.5 (Slow shutter)
S/N Ratio	More than 48dB (AGC off)
Lens	f2.8 ~ 12mm / F1.4 ~ F2.8
Viewing Angle	Wide: 103 (Horizontal) / 54° (Vertical) / 122° (Diagonal) Tele: 31° (Horizontal) / 17° (Vertical) / 36° (Diagonal)
IR LED	3 Units
IR Effective Distance**	Default: up to 30 meters IR Enhanced Mode: up to 50 meters
IR Shift	YES
Smart Light Control	YES
White Balance	ATW
AGC	Auto
IRIS Mode	AES
WDR	YES
POE	YES (IEEE 802.3af)
External Alarm I/O	YES (1 input / 1 output)
RAM	20MB
MicroSD Card Slot	YES (support up to 64GB microSD card)
Weather-proof	IP66
Vandal-proof	IK10
Operating Temperature	-25°C ~ 50°C
Operating Humidity	90% or less relative humidity
Power Source (±10%)	12V / 1.5A
Current Consumption (±10%)	310mA (IR LED OFF); 565mA (IR LED ON)
Power Consumption (±10%)	12.95W Max (PoE) ; 12.95W Max (PoN) ; 12W Max (DC Adapter)
Net Weight (kg)	1.5



## ● SPECIFICATIONS (CONTINUED)

■ Audio	
Line in	YES (Mono)
Line out	YES (Mono)
■ Others	
TV-out	YES
Mobile Surveillance	iOS & Android mobile devices
EaZy Networking	YES
Motion Detection	YES
Event Notification	<b>Push Video</b> / FTP / Email / SMS
3-Axis	YES
Privacy Mask	YES
RTC (real-time clock)	YES
Digital Pan / Tilt / Zoom	YES
Minimum Web Browsing Requirements	<ul style="list-style-type: none"> <li>• Intel core i3 or higher, or equivalent AMD</li> <li>• 2GB RAM</li> <li>• AGP graphics card, Direct Draw, 32MB RAM</li> <li>• Windows 10, Windows 8, Windows 7, Windows Vista &amp; Windows XP, DirectX 9.0 or later</li> <li>• Internet Explorer 7.x or later (Windows Edge not supported)</li> </ul>

\*The specifications are subject to change without notice.

\*\* Using IR enhanced mode and slow shutter speed, the distance can be extended even longer.

## 3-AXIS ILLUSTRATION

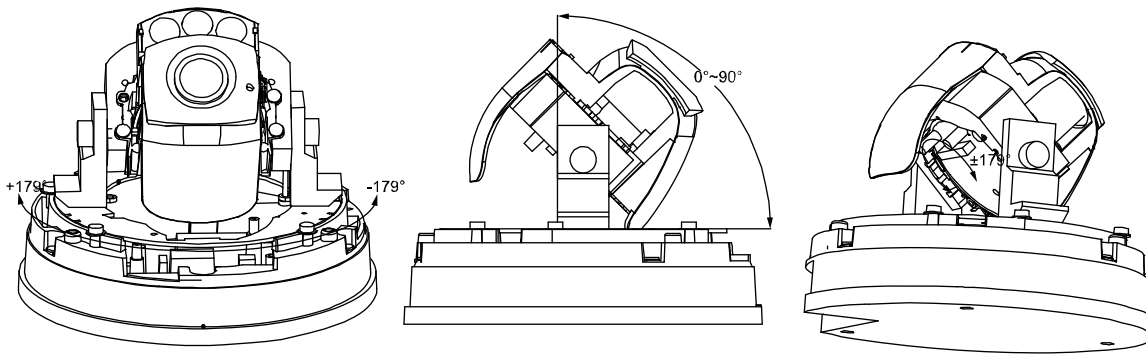

## DIMENSIONS

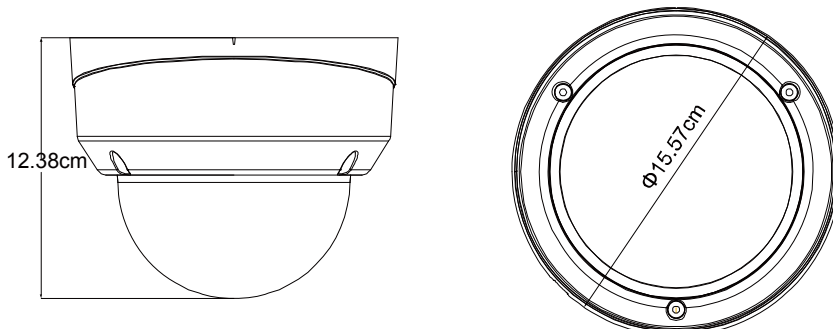

Dimensional tolerance: ± 5mm



## OPTIONAL BRACKETS

### ■ AVM542-BKT(A)

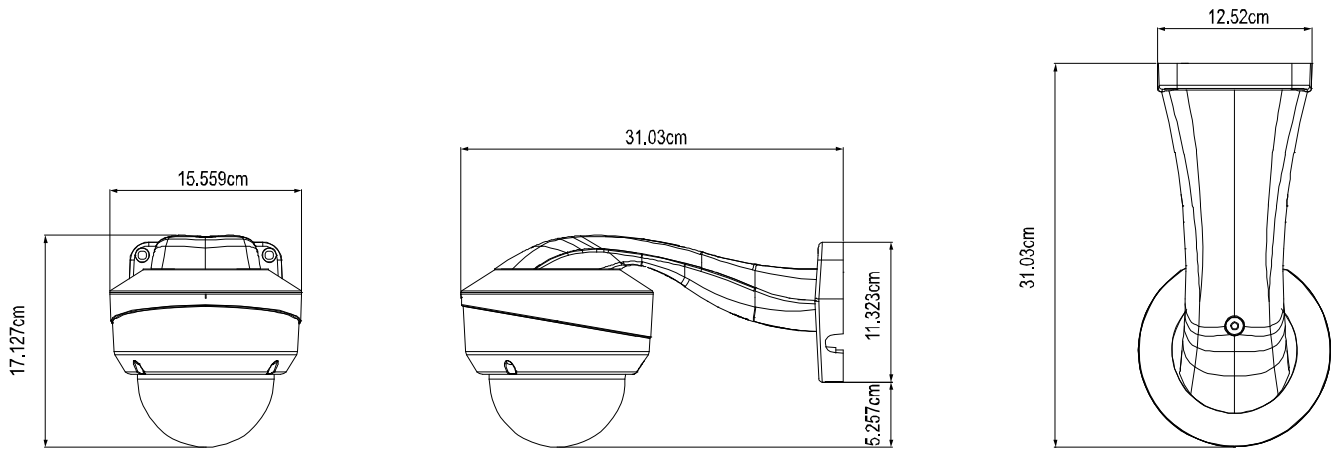

Dimensional tolerance: ± 5mm

### ■ PAVM542-BKT(B)

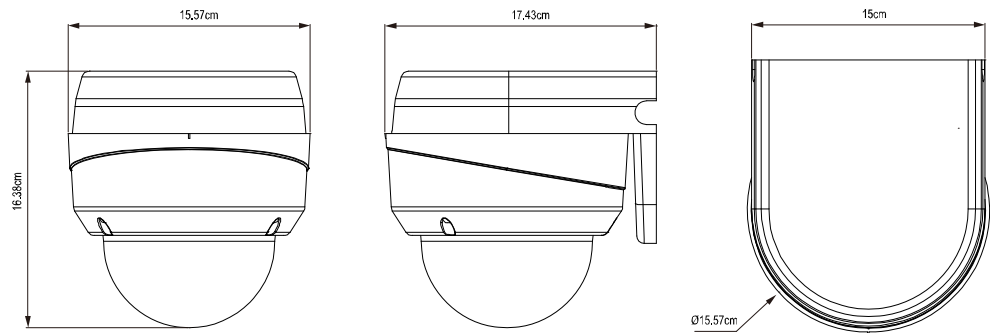

Dimensional tolerance: ± 5mm



## OPTIONAL BRACKETS (CONTINUED)

### ■ AVM542-BBKT

Used as a bracket to mount the camera on the ceiling and collect the cables.

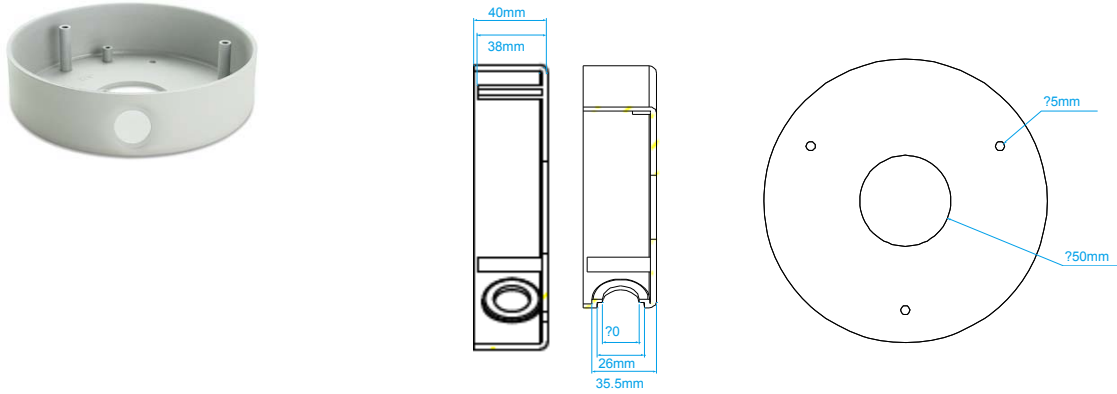

Dimensional tolerance:  $\pm 5\text{mm}$

### ■ AVM542CEIL-BKT (Coming Soon)

Used as a bracket to mount the camera into the ceiling.

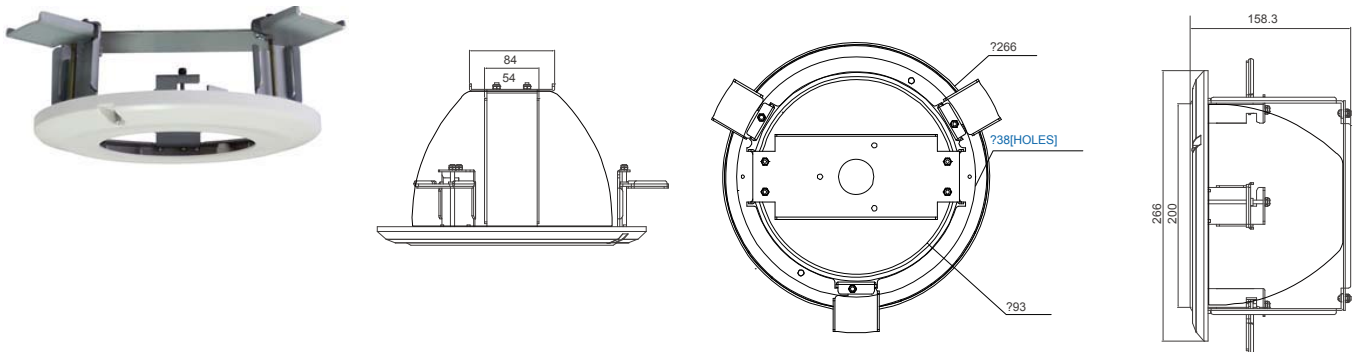

Dimensional tolerance:  $\pm 5\text{mm}$