

AVT1105

HD CCTV 1080P IR Bullet Camera



● FEATURES

- (1) 1/2.7" CMOS Sensor with 1080P video output
- (2) Low light sensitivity of 0.1 Lux / F1.8, 0 Lux (IR LED ON)
- (3) External alarm I/O device connection
- (4) New IR technology adapted to enhance brightness at night
- (5) Day and night 24-hour surveillance with IR effective distance up to 25 meters
- (6) IP66 for weather-proof application
- (7) Camera parameters adjustable when used with AVTECH HD CCTV DVR

● DIMENSIONS*

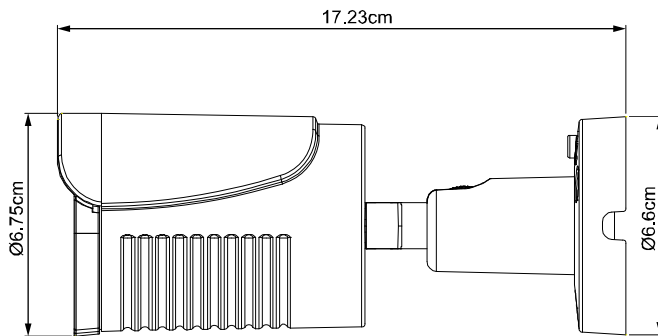

*Dimensional Tolerance: ± 5mm

● SPECIFICATIONS*

MODEL	AVT1105	
Pick-up Element	1/ 2.7" CMOS image sensor	
Number of Pixels	1930(H) x 1088(V)	
Video Frame Rate	1080P@30fps / 1080P@25fps	
Min. Illumination	0.1 Lux / F1.8, 0 Lux (IR LED ON)	
S/N Ratio	More than 48dB (AGC OFF)	
Shutter Speed	1/30 (1/25) sec ~ 1/720000 (1/600000) sec	
Lens	f2.8mm / F1.8	f3.6mm / F1.8
Lens Angle	118° (Horizontal) / 65° (Vertical) / 136° (Diagonal)	89° (Horizontal) / 46° (Vertical) / 108° (Diagonal)
IR LED	2 units	
IR Effective Distance	Up to 25 meters	
IR Shift	YES	
Day & Night Mode	YES	
IRIS Mode	AES	
White Balance	AUTO / USER / PUSH / 8000K / 6000K / 4200K / 3200K	
AGC	Adjustable	
Sharpness	Adjustable	
Flickerless	50HZ / 60HZ / OFF	
BLC	Adjustable	
External Alarm I/O	YES (1 in / 1 out)	
IP Rating	IP66	
Operating Temperature	-40°C ~ 50°C	
Operating Humidity	90% or less relative humidity	
Power Source (±10%)	DC12V / 500mA	
Current consumption (±10%)	150mA (IR LED OFF) / 310mA (IR LED ON)	
Power consumption (±10%)	3.7W	
Net Weight (kg) (±10%)	0.36	

* The specifications are subject to change without notice.